



K-FLEX ACCESSORIES

Complete range of solutions
for the installers





PVC

K-FLEX PVC RS 590 SHEET

A rigid PVC self-rolling sheet with a smooth grey surface. The sheet adheres perfectly to all cylindrical pre-insulated surfaces. Light and easy to use, this non-drip self-extinguishing product protects the insulation as well as enhancing overall external appearance. To maintain the product features intact, in the winter season the rolls should be stocked at room temperature for 24 hours prior to their use.

Use:

It is used as a protective covering and to enhance the external appearance of large and small cylindrical pipes insulated with elastomeric material, glass wool mats, rock wool mats, polyurethane and polystyrene pipe coverings.

Application:

- Measure and cut a section of the PVC sheet based on the circumference of the insulation, leaving an excess of a few centimeters for overlapping the joining edges.
- Wrap the sheet around the insulation
- Seal the borders with plastic rivets (see reference in the section "components: fixing products").

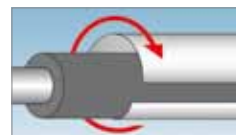

Measurements
Length: 25 m
Width: 1 m

TECHNICAL CHARACTERISTICS

Base	Rigid PVC
Fire	Homol. MI700C50CD100009 - self-extinguishing
Colour	Standard light grey
Packaging	Rolls
Sheet thickness	0.30 mm ÷ 0.35 mm
Temperature range	from -25 °C to +70 °C
Thermal conductivity λ	0.16 W/(m•K)
Permeability to vapour μ	1.0 gm ² 24h Pa



PVC

K-FLEX PVC 200 type W ELBOWS

90° single-piece elbows in laminated plastic. Apart from enhancing the overall appearance of the insulated part, they increase protection against impact.

Application:

After having taken the measurements and having chosen the suitable type of elbow, place it onto the part to be covered. The internal borders should overlap to allow for fastening with the appropriate plastic rivets (see the section "components: fixing products").

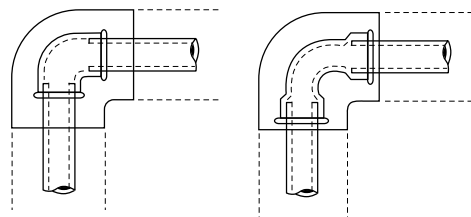

Measurements:

Thicknesses mm: 20, 25, 30, 40, 50, 70, 80, 90
Tube diameters mm: from 17 to 114; inches: from 3/8" to 4"



PVC

K-FLEX PVC type T

Laminated plastic PVC singlepiece T sections. Ideal for protecting insulated pipes of medium and large diameters.

Application:

The external diameter of the PVC T section also includes the thickness of the insulation.
E.g.: to cover a pipe with a 76 mm Ø (A-B), and a 32 mm thick insulation (C), a 140 x 140 type should be ordered.

Measurements:

External diameter (main./branch.) mm: from 52/52 to 245/245 from 67/61 to 108/61 from 108/67 to 245/218

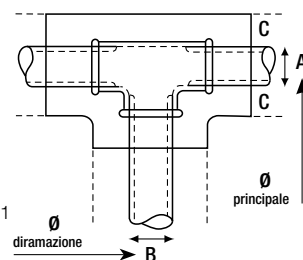

PVC

K-FLEX PVC type SE 90° ELBOWS

Single piece 90° plastic sheet elbows. Apart from improving overall appearance, the product provides protection against UV rays and impact.

Application:

After having taken the measurements, choose the suitable elbow and apply it to the part to be insulated. The internal borders will overlap to allow sealing with the special plastic rivets (see the section "components: fixing products").

Measurements:

Thicknesses mm: 20, 25, 30, 40, 50, 60, 70, 80, 90, 100
Tube dimensions mm: from 12 to 356; inches: from 3/8" to 14"

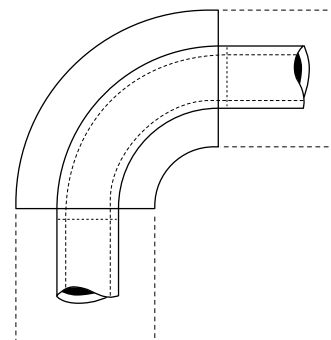



ALU

K-FLEX ALU EMBOSSED R 200



Self-wrapping embossed protection sheet in rolls of 99.5% pure aluminium.
Sheet thickness 0.1 and 0.2 mm
Supplied in 1 m wide rolls

Properties: the product grips perfectly to all cylindrical pre-insulated surfaces, it is light, easy to handle, protects the insulation and enhances the overall appearance.
It is incombustible.

Possibilities of use: used as a protective covering, it also improves the overall appearance of small and large cylindrical pipes insulated with elastomeric, fibre-glass mattresses, mineral wool, polyurethane and polystyrene.

Application: if not already pre-cut, cut the sheet to the required circumference. Wrap the sheet around the insulation, seal the longitudinal edges with adhesive foil tape and plastic rivets.

ALU

K-FLEX BLECH MT-CU



99.5% PURE ALUMINIUM SHELL and 90° ELBOWS
with a thickness ranging from 0,6 and 0,8.

MT 500: male and female ball swaged edges calendered tube,
with reinforced length-wise drilled sealing system.

Measurements:

Tubes Ø 70 = Length 500 mm
All the others = Length 1000 mm

CU 501: 90° preformed segmented elbows with female-female ball swaged edges.

Application on tubes:

- The MT 500 tube diameter is slightly greater than that of the corresponding CU 501 elbow, which makes the connection between the two parts much easier.
- The edges of the joints are fixed together by using the short screws in the holes provided.

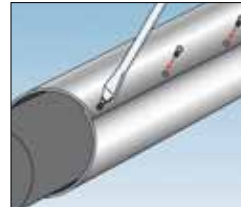
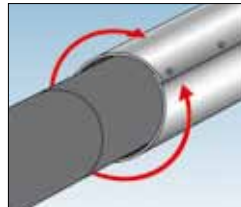

Application of CU501 elbows:

- A - Open the segments of the elbow and place them around the insulated pipe.
- B - After the sections have been correctly positioned, seal the elbow with short screws using the holes provided.
- C - Connect the MT 500 tube by attaching male edge to female edge.

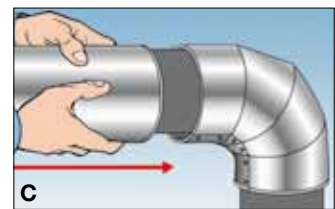
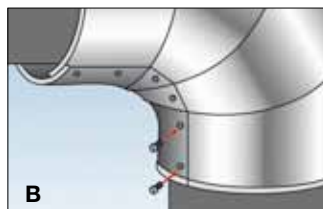
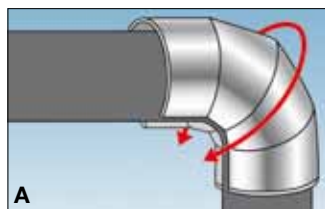



TAPES



VINYL K-FLEX BAND

Flexible, robust and resistant to external agents, used for covering pipes insulated with elastomeric insulation or other materials. The small roll sizes allow for applications even in tight and narrow spaces. The wide range of colours available allows for a correct colour-coding of pipes, in compliance with the law.

Colours:
red
green
blue
grey (K-Pack RS 590 type)
light grey
black

Measurements:
Thicknesses mm: 10/100
Lengths m: 50, 25
Width cm: 10



TAPES



K-FLEX GUTTAGENA PVC BAND

Twice the thickness compared to the previous range, it is ideal for finishing PVC sheet insulation coverings (eg. K-FLEX PACK RS 590). The GUTTAGENA band is available in one colour, light grey, and is matt finished.

Measurements:
Thicknesses mm: 20/100
Lengths m: 50
Widths mm: 50, 100



TAPES



K-FLEX ANTI-CONDENSATION TAPES

ANTI-CONDENSATION TAPES

Black, reinforced self-adhesive closed-cell elastomeric foam tape, with a disposable protective lining.

Measurements:
Thicknesses mm: 3, 6
Lengths m: 10, 15
Widths mm: 50, 75, 100



ECO ANTI-CONDENSATION TAPE

Green, reinforced self-adhesive closed-cell elastomeric foam tape (ECO), with a disposable protective lining.

Measurements:
Thicknesses mm: 3
Lengths m: 15
Widths mm: 50

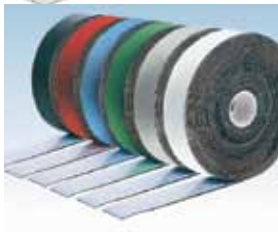

K-FLEX ANTI-CONDENSATION COLOR TAPE

Self-adhesive, reinforced closed-cell elastomeric foam tape with COLOR SYSTEM coating and a disposable protective lining. Available in the range of standard RAL colours.

Measurements:
Thicknesses mm: 3, 6
Lengths m: 15, 7, 5
Widths mm: 50, 100

Range of 8 stock colours:

- | | | | |
|--|----------------|--|----------------|
| | RAL 5012 blue | | RAL 3000 red |
| | RAL 6032 green | | RAL 9011 black |
| | RAL 7035 grey | | RAL 1019 sand |
| | RAL 9002 white | | RAL 3015 pink |



K-FLEX NA 310 TAPE

Rubber anti-condensation tape with embossed aluminium sheet. Black, closed-cell elastomeric foam tape, 3 mm in thickness, with, on the underside, a reinforced self-adhesive mesh and a disposable protective lining, and a surface covered by 0.05 mm thick embossed aluminium foil. Fire - Class 0 BS 476 PT 7

Measurements:
Thicknesses mm: 3
Lengths m: 10, 15, 20
Widths mm: 50, 100



K-FLEX ACCESSORIES - TAPE



TAPES

ALUMINIUM TAPE



NAREINFORCED ALU AR 107 TAPE

Reinforced self-adhesive tape

99,9% aluminium, self-adhesive 0,30 μ tape, reinforced with fibreglass, with a disposable protective lining.
Fire - Class 0 BS 476 PT 7
Suitable for endcappings, pipe joints, ventilation ducts and other elements insulated with aluminium sections.

Measurements:

Thickness: 30 μ
Lengths m: 50
Widths mm: 50, 75, 100



ALU AA 130 TAPE

Smooth aluminium self-adhesive tape for covering joints

Pure aluminium, self-adhesive 30 μ tape, with a smooth, reflective, adhesive surface on one side and a disposable protective lining.
Fire - Class 0 BS 476 PT 7
Suitable for endcappings, pipe joints, ventilation ducts and other elements insulated with aluminium sections.

Measurements:

Thickness: 30 μ
Lengths m: 30
Widths mm: 50, 75, 100



BLACK ALU TAPE

Black aluminium self-adhesive tape for covering joints

Pure aluminium, self-adhesive 30 μ tape with a smooth surface and a disposable protective lining.
The tape finishing appears the same as the elastomeric surface.
Suitable for endcappings, pipe joints, ventilation ducts and other elements insulated with K-FLEX elastomeric insulation.
Fire - Class 0 BS 476 PT 7.

Measurements:

Thickness: 30 μ
Lengths m: 50
Widths mm: 30, 50, 75, 100



WHITE ALU TAPE

White aluminium self-adhesive tape for covering joints

Pure aluminium, self-adhesive 30 μ tape with a smooth surface and a disposable protective lining.
Fire - Class 0 BS 476 PT 7
Suitable for endcappings, pipe joints, ventilation ducts and other elements insulated with laminated aluminium and/or K-FLEX insulation.

Measurements:

Thickness: 30 μ
Lengths m: 50
Widths mm: 30, 50, 75, 100



TAPES



PVC AT 070 SELF-ADHESIVE TAPE

Black/grey PVC self-adhesive tape for covering joints.

Measurements:

Length m: 25
Widths mm: 25, 38, 50



PE INSULATION TRIMMING

Self-adhesive closed-cell wired foam PE packing, used to cover the seal flange in air-conditioning ducts.

Measurements:

Thickness mm: 3
Length m: 20
Widths mm: 15, 20, 25



BITUMINOUS CONGLOMERATE INSULATION TAPE

Made from a mixture of synthetic rubber, bitumen and cork powder. It is ideal for preventing condensation forming on pipes. No further gluing is required because the tape is self-adhesive and sticks firmly to all surfaces.

Measurements:

Thickness mm: 3
Length m: 9,15
Widths mm: 50

COMPONENTS

K-FLEX KNIVES



KNIFE FOR CUTTING TUBES

Designed with a special grip to allow you to make longitudinal cuts in insulation tubes, enabling you to mount them on previously installed pipes. It is supplied with 5 spare blades.



In order to make clean, straight cuts it is important to always use a sharp blade. The blade must flow freely along the cutting line (as a guide, use the writing line on the tube). To avoid tearing, make sure that the tool does not snag on the insulating material.

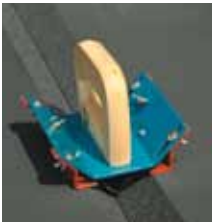

KNIFE FOR MAKING 90° CUTS

A specialist tool with an adjustable blade for making 90° cuts in the thickness of the elastomeric sheet. This tool is designed to allow you to bend the sheet at an angle of 90°.

COMPONENTS

ALUMINIUM ENDCAPPING IN ROLLS



Special endcapping in ribbed aluminium for sealing the ends of insulated pipes.

Available in the following colours: SILVER, LIGHT GREY, BLACK, BLUE AND RED. Length of rolls - 10 m. The different colours make it easier to identify the various pipes of a system.

Measurement:

Internal/external \varnothing mm: 18x32, 23x32, 28x32, 38x42, 48x42, 58x42



Place a cap of insulating material over the end of the pipe.



Cut a strip of the endcapping long enough to wrap around the circumference of the pipe covering.

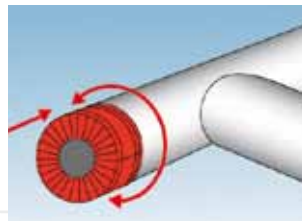

Wrap the endcapping around the end of the insulated pipe and around the edges of the pipe covering.

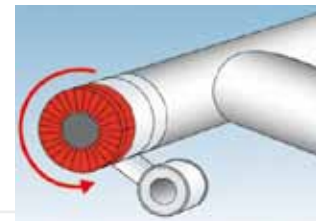

Fix the endcapping to the pipe covering with the correct selfadhesive tape.

COMPONENTS

FASTENING PRODUCTS



Important for correctly fastening PVC and AL CLAD sheets.
PLASTIC RIVETS: box of 100 WHITE and GREY rivets.
PUNCH: straight/angular

K-FIX. Galvanized steel installation hangar spike with a 50x50 mm base. With adhesive and nonadhesive surface, with a 2,7 mm diameter stick pike, and a self-blocking 30 mm diameter disc.

It can be applied to flat metal surfaces for fastening insulation material in sheet or roll form (mineral wool, polyethylene, etc.). Strongly recommended for air-conditioning ducts.

Temperature range min/max +10 °C/ +80 °C. Supplied in boxes of 100 pieces. Length of pins - from 19 to 114 mm.

INSTRUCTIONS FOR USE on PVC and AL CLAD

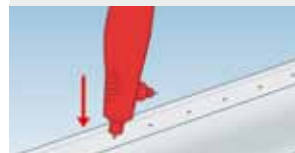

Punch holes along the overlap of the sheet, going through both layers.



Insert the plastic rivets in the holes, pressing them firmly into the insulation layer.



Apply the chosen insulation and insert the self-locking disc. If the shank exceeds the thickness of the insulating material, cut away the excess. Non-adhesive K-FIX: weld the plate to the metal surface.



COMPONENTS

SPECIAL THINNERS FOR K-FLEX ADHESIVES



Before covering the surfaces to be insulated, it is advisable to clean them with the special K-FLEX thinners which, thanks to its composition, is also suitable for use with K 414, K 420 or K 425 adhesives. Cleaning of all surfaces with the special K-FLEX thinners also improves the performance of the adhesives. The special K-FLEX thinners can be also used for cleaning brushes and spatulas used to spread the glue.

Available in 1 litre tins.



COMPONENTS

K-FLEX GLUES

INDICATED CONSUMPTION OF 1 LITRE OF ADHESIVE



K-FLEX K 414, K 420 and K 425 glues have been specifically designed for use with K-FLEX elastomeric foam insulation material. The securely bonded surfaces and joints are resistant to ageing and atmospheric agents, and preserve the technical characteristics of the insulating material.

K 414 ADHESIVE in tins of: 0.5 - 0,8 - 2.6 litres

K 420 ADHESIVE in tins of: 0.26 - 1 - 2.6 litres

K 425 ADHESIVE in tins of: 0.85 litre (complete with glue activator)

TUBES	GLUED TO THE HEADS	GLUED LENGTHWAYS
thickness mm 9	every 1,350 m	every 150 m
thickness mm 13	every 500 m	every 100 m
thickness mm 19	every 300 m	every 80 m
thickness mm 25	every 220 m	every 60 m
thickness mm 32	every 180 m	every 40 m
thickness mm 40	every 139 m	every 27 m

SHEETS: 1 litres every 7m²

L'ISOLANTE K-FLEX does not accept responsibility for different values to those indicated.

COMPONENTS

K-FINISH PAINT



K-FINISH is a water-based paint for coverings on internal and external installations insulated with K-Flex materials.

With its polymerized acrylic base, it does not pollute and does not give off odours, and is particularly recommended for all indoor uses. Quick drying, it offers excellent protection. Coats of white paint, applied over a layer of K-FINISH will maintain their colour even in dark environments. The colours are resistant to light.

It is advisable to paint the surface of externally insulated pipes to protect them against harsh weather conditions and UV rays. For further protection it is advisable use a double layer of K-FINISH paint. Available in 2.5 litre tins, and on request, in various colours.

COMPONENTS

K-FLEX COLOR PAINT - Coloured water-based paint for retouching



Special paint for retouching the surfaces of COLOR coverings, scratched or damaged during installation. The paint, ready for use, should be applied with a soft brush.

Available in 0.5 litre tins.

range of 8 stock colours:

	RAL 5012 blue		RAL 3000 red
	RAL 6032 green		RAL 9011 black
	RAL 7035 grey		RAL 1019 sand
	RAL 9002 white		RAL 3015 pink

COMPONENTS

K-FLEX ADHESIVE DISPENSER



A useful accessory that controls flow and helps spread adhesives evenly on insulation surfaces, avoiding having to continuously dip the brush into the tin of adhesive.



The adhesive correctly diluted, is manually pumped through the brush.

COMPONENTS / INSULATING SUPPORTS



COMPONENTS	K-SIL SILICONE 1209
	Available in Alu color, 310 ml cartridges Recommended for al K-FLEX AL CLAD SYSTEM applications
	SIMSON ISR 70-03 MARINE SILICONE
	Available in Black and Gray color, 290 ml cartridges Recommended for al K-FLEX IN CLAD SYSTEM applications



INSULATING SUPPORTS	PIPE SUPPORTS WITH AND WITHOUT COLLAR	
	Specifically designed to ensure a correct insulation thickness where joints are made. The PIR central section, which covers the whole circumference and is attached to two K-FLEX insulating material sections, ensures a perfect continuity of the vapour barrier. Longitudinal sealing is obtained by means of the self-adhesive overlap. The external cover is in PVC. The support is also available with a collar and a special metal support which, when fixed to the supporting framework, ensures greater overall installation stability.	Measurements: Thicknesses mm: 13, 19, 25, 32 Tube diameter mm: from 18 to 160; inches: from 3/4" to 5"
		TECHNICAL CHARACTERISTICS



1 - Place the insulating support around the pipe.



2 - Spread K-FLEX adhesive onto the half-collars.



3 - Seal lengthways using the adhesive overlap.



4 - Fix the collar around the support.



5 - Glue the support to the insulating material.

The insulating supports are also available in K-FLEX ECO, SOLAR, AL CLAD, COLOR, in the same measurements as those indicated for K-FLEX ST.

